

Data Sheet



Article number: 03553020

Description: Fluro hydraulic rod end FPR 20U

Measures

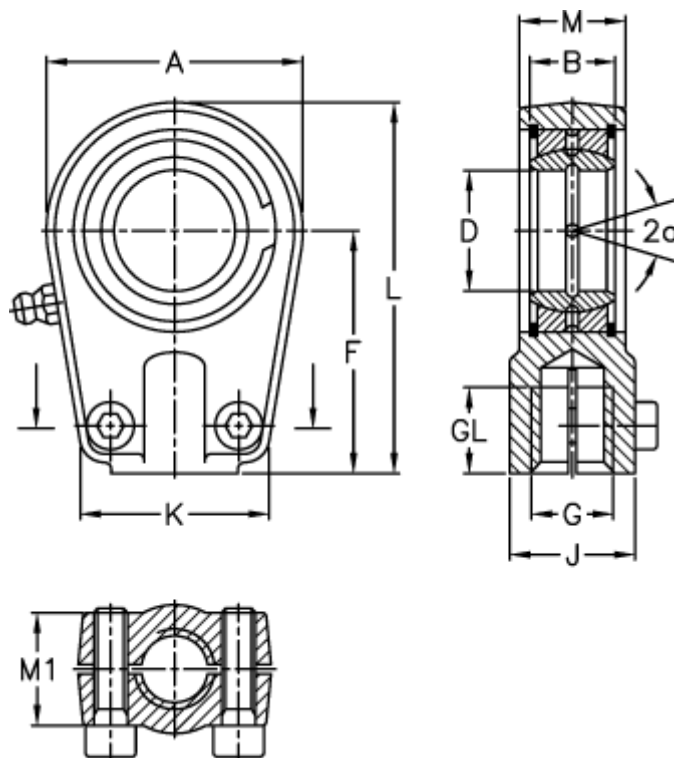

A	= 56	J	= 25
a (degrees)	= 9	K	= 46
B	= 16	L	= 80
D	= 20	M	= 19
Dynamic load C (kN)	= 30	M1	= 21
F	= 50	Static load C0 (kN)	= 72
g	= M16x1,5	Torque (N m)	= 25
GL	= 17	Weight	= 400